

DIGITAL VOICE RECORDER

MODEL:PVR825

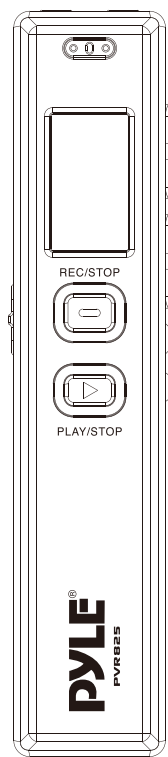

INSTRUCTION MANUAL
www.PyleAudio.com

LOCATION OF INDICATORS

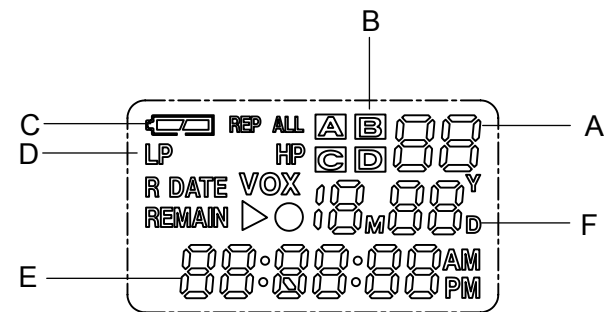

- | | |
|------------------------|---------------------|
| A. Year/Message | ▷ Play logo |
| B. File folder | ○ Record logo |
| C. Battery indicator | HOLD Hold indicator |
| D. Recording quality | VOX Voice activate |
| E. Elapsing of message | REP Repeat 1 |
| F. Month/Date | REP ALL Repeat all |

IMPORTANT SAFETY INSTRUCTIONS

Read this manual before use and keep it for future reference

PRECAUTIONS

To maintain optimum performance:

Do not use unit in places which are extremely hot, cold, dusty or high humidity place, in a high humidity area such as a bathroom or near a heater.

Do not use or keep the unit in following places

- In an area exposed to direct sunlight (e.g inside car where it become extremely hot).
- Near sources of strong magnetism such as television, speakers or magnets.
- Where there is a lot of movement or vibration, such as in a car dashboard or an unstable shelf.

For safety

- Do not attempt to disassemble this unit.
- make sure that pins or other foreign objects not to get inside the Unit.
- Take care not to drop the unit or subject it to strong shocks.

Note on listening with the earphones

- listen at moderate volumes to avoid hearing damage.
- Do not wear the earphones while driving or cycling. It may create a traffic hazard.
- You should use extreme caution or temporarily discontinue use in potentially hazardous situations such as walking, Jogging, etc.
- If you hear no sound, do not turn the volume up high because the music could suddenly begin at high volume. To avoid hurting your ears or damaging the headphones, turn the volume control to the lowest level before starting playback and slowly turn it up to the desired level.

LOCATION OF KEYS

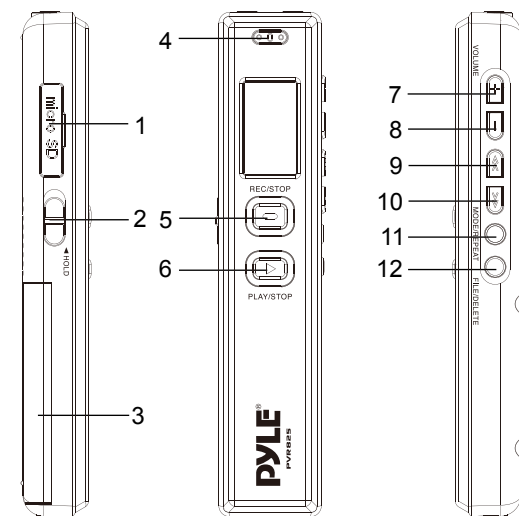

- | | | | |
|---------------------|---|-------------|----|
| Micro SD socket | 1 | Volume + | 7 |
| Hold | 2 | Volume - | 8 |
| Battery compartment | 3 | REV | 9 |
| Mono Microphone | 4 | NEXT | 10 |
| REC/STOP | 5 | MODE/REPEAT | 11 |
| PLAY/STOP | 6 | FILE/DELETE | 12 |

OPERATION

BATTERY INSTALLATION

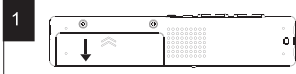

Push to open battery cover.

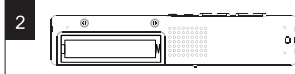

Insert 1pcs of "AAA" size batteries with correct polarity.

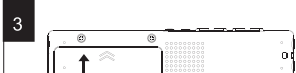

Close the battery cover.

NOTE: Replace batteries don't affect messages or files stored on unit.

BATTERY PRECAUTIONS

Please follow below advices while handle batteries:

1. Use only the size and type of battery specified.
2. Be sure correctly install battery as logos carved on battery compartment. Batteries reversed may lead the unit defect.
3. If the device is not to be used for a long period of time, remove the battery to prevent damage or injury from possible battery leakage.
4. Do not try to recharge battery not intended to be recharged; they can overheat and rupture. (Follow battery manufacturer's directions.)

4

OPERATION (CONTINUED)

SET HOLD

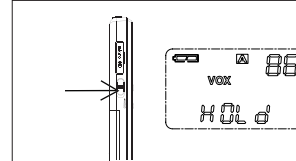

Slide the HOLD key up to lock the unit, the unit only show the file numbers and can't play or record message. If any key is pressed, 'HOLD' is shown. Slide the HOLD key down, the unit can work.
* If unit doesn't work, check HOLD key off.

SET VOICE ACTIVATE(VOX)

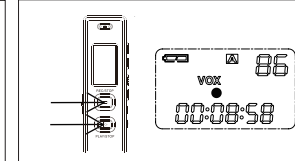

In standby mode, press REC/STOP key to record, then press PLAY/STOP key repeatedly to set voice activate(vox on or no), set vox on, the 'VOX' icon shows on LCD. set vox off, the 'VOX' icon disappears on LCD.

SELECT A FILE FOLDER (A,B,C,D)

Each file folder can store 99 messages, and you can save 396 messages total in the unit.

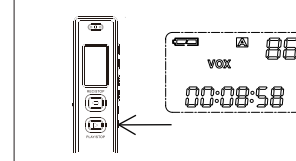

Power on unit, press FILE/DELETE key repeatedly to select folder to record message.
*Factory setting is "A".

NOTE:

Each time you record a message, the unit will assign number automatically. The file number will be shown on LCD. *If the units is full, "FULL" will be appeared on LCD, you may move your files into computer by reader, or replace a new SD card to record continuously.

6

OPERATION (CONTINUED)

TO TURN UNIT ON AND TIME SETTING

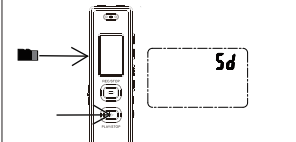

Insert SD card, Put SD card into Micro SD socket. Time is shown on LCD.(Time mode)
Press PLAY/STOP or REC/STOP key, then the file number appears on LCD(Standby mode), or long press REC/STOP key to goto record file directly.
In order to use the micro SD card, the microSD card must be in FAT16 or FAT32 format.
To format microSD card to FAT16 or FAT32 format, please refer to page 11.

In Standby mode, press and hold MODE/REPEAT key, the date and time show on LCD and the Year indicator blinks, and press "+" or "-" to adjust it, then press "<=>" or ">=>" to goto next item, and it blinks. At last press PLAY/STOP key to confirm and return to Standby mode, or press REC/STOP key to cancel and return, the date and time will always show on LCD except for removing the battery.

TO TURN UNIT OFF

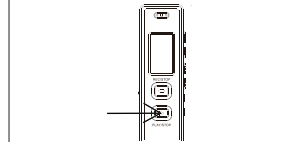

To turn unit off, press PLAY/STOP key more than 2 seconds to power unit off. The unit will turn off automatically after 60 seconds without any key pressed, time is shown on LCD(Time mode).

SET SOUND QUALITY

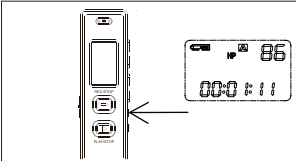

In Standby mode, press MODE/ REPEAT key repeatedly to select your desired sound quality. "HP" or "LP" is displayed on LCD.

*Factory setting is "HP"

There are 2 recording quality for your choice,
For best sound quality, select HP(High Play);
448 hours recording with SD card memory 2GB.
For longer recording time, select LP(Long Play);
224 hours recording with SD card memory 2GB.

SET VOLUME LEVEL

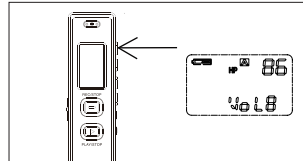

In Standby mode, or while playing, press VOLUME+ or VOLUME- key to increase or decrease volume level.
*0" is minimum, "9" is maximum.

5

OPERATION (CONTINUED)

NORMAL RECORDING

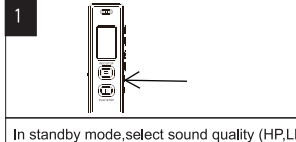

In standby mode, select sound quality (HP,LP) with MODE/REPEAT key.
*Factory setting is "HP".

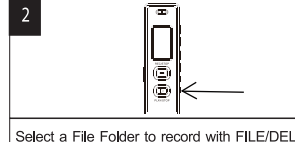

Select a File Folder to record with FILE/DELETE key.
*Factory setting is "A".

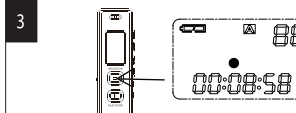

Press REC/STOP key once, "●" icon show on LCD and start recording. New file number shows on LCD. To stop recording, press REC/STOP key again.

*When you use external microphone, put it into mic jack on unit.

NOTE:

* Recording level is automatically sets by unit. To record another message, simply press REC/STOP key, Message(file) number will increase one by one.
* For normal voice recording, distance of 5-9 inches is appropriate.

7

OPERATION (CONTINUED)

VOICE ACTIVATED (VOX) RECORDING

Set the VOX "On" to record just only when sound is detected.
The unit will be paused recording when no sound is detected , and start recording again automatically when sound is detected.

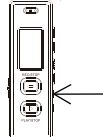
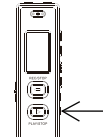
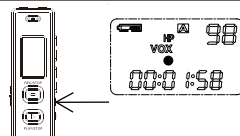
<p>1</p> 	<p>2</p> 
<p>In standby mode,press MODE/REPEAT key, and select sound quality (HP,LP) . *Factory setting is "HP" .</p>	<p>Select a File Folder to record with FILE/DELETE key. *Factory setting is "98" .</p>
<p>3</p>  <p>At standby mode, press REC/STOP key once to start recording. Then press PLAY/STOP key repeatedly 'vox' icon is show on the LCD. To stop recording, press REC/STOP key again. *On VOX mode, recording is automatically start when sound is detected. When there is no sound, stop recording automatically and elapsing time blinks and stops until sound is detected.</p>	<p>NOTES: .The first period of sounds activate the unit and may not be recorded. .A variation in voice level during recording will not stop the unit, two seconds of silence is required to stop the recording. .For constant recording, see previous page. .The built-in audio level automatically sets the recording level. .For normal voice level, distance of 5-9 inches is appropriate.</p>

8

OPERATION SPACE (CONTINUED)

REPEATEDLY PLAYBACK MESSAGES

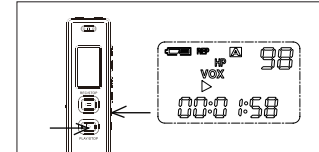

In standby mode, Press FILE/DELETE key to select the desired folder and press(<<) or (>>) key to select the desired message. press PLAY/STOP key to playback message. Press MODE/REPEAT key repeatedly to select "REP" or "REP ALL".
For "REP", you can repeat playback current message.
For "REP ALL", you can repeat playback current folder message.
if you want stop repeat playback message, press MODE/REPEAT key repeatedly to disappear the "REP" or "REP ALL".

DELETE SINGLE MESSAGE

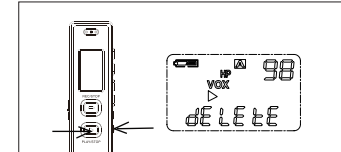

In standby mode, Press FILE/DELETE key to select the desired folder and press (<<) or (>>) key to select the desired message number, press PLAY/STOP key to playback. While playing a message, press the FILE/DELETE key once,the "dELEtE" appear on LCD and blink,Then press FILE/DELETE key again ,the message is deleted.

DELETE ALL MESSAGES

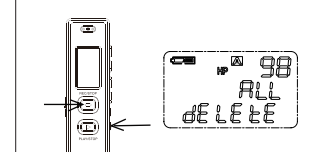

In standby mode, press and hold REC/STOP and FILE/DELETE key for 2 secs ,and "ALL dELEtE" shows on LCD , then press FILE/DELETE key once to delete all messages within current folder .

IMPORTANT NOTES:
Once message(s) is deleted ,they can not be recovered.

10

OPERATION (CONTINUED)

PLAYBACK MESSAGES

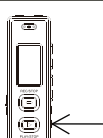
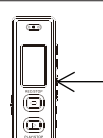
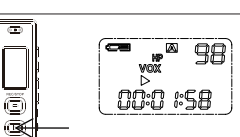
<p>1</p> 	<p>2</p> 
<p>In standby mode and select a File Folder with FILE/DELETE button.</p>	<p>Select file number to play with (<<) (>>)key.</p>
<p>3</p>  <p>Press PLAY/STOP key once to playback a message . Then press and hold PLAY/STOP key for 2 secs. to stop playing . While playing press PLAY/STOP key for pause and the elapsing time blink and press the PLAY/STOP key again to play. * While playing press REC/STOP key,it will show the recording time of this file for two seconds.</p>	<p>* While playing,long press "<<<" or ">>>" key for fast rewind or fast forward. EARPHONE JACK For private listening, connect an earphone to Earphone jack The speaker will automatically disconnected when an earphone plug inserted into Earphone jack.</p>

9

Downloading and uploading Files

1. Take out the SD card from the unit ,then insert it into the Card Reader,then connect your PC.

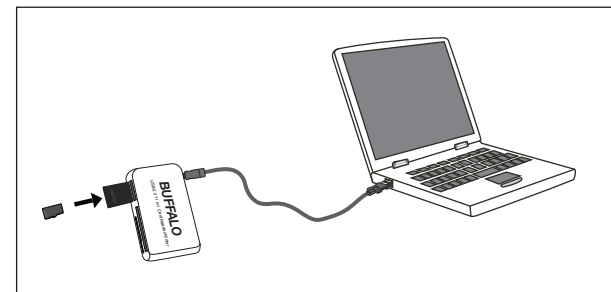

2. Open the removable Disk ,there are four folder (A,B,C,D) for recording files ,so you may copy these files in your PC for safe backups ,delete files or format this disk .

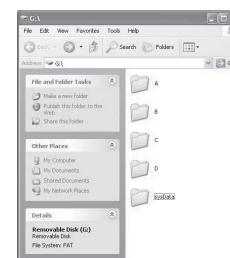

11

Installing software and operation

All recorded voice files need to be converted as WAV format file for playing on PC by the provided Voice manager software (CD-ROM) .

1. Put the provided disk into the CD Driver ,then open the disk in "My Computer" .
2. Double-click on the drive's icon and run the setup program.
3. Follow the on-screen directions to complete the installation process.
4. After installation ,finding the Voice manager icon and clicking it to open it.



5. Taka out the SD card from the unit ,then insert it into the Card Reader,then connect your PC.
6. Select the desired recorded voice file from your SD card (" My computer " – "Removable disc" – "RECORD") , or You may download Voice files in your PC in advance,then select the desired voice files as right path .
NOTE:There are two removable disc drivers available,choose the drive containing the "RECORD" folder.
7. Select the desired saving address for converted WAV files,then click "Convert" to convert the files to WAV.
8. Then press " OK " to confirm it .
Note :The converted WAV files will be saved in the appointed address with the same file name as the original format file's .

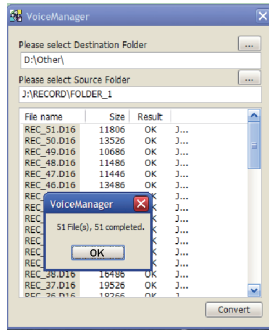

12

SPECIFICATIONS

Message number	Max. 99 (sigal file)	
	Max.396(4 files total)	
Recording Time 2GB memory (not including)	LP	HP
	448hours	224hours
Jacks	MICROPHONE	Ext.Mic (D3.5mm, Mono w/switch)
	EARPHONE	EarPhone (D3.5mm, Mono w/switch)
Speaker	8 ohms dynamic speaker	
Output power	Speaker	30 mW
	Earphone	0.5 mW
R/P frequency response	300 Hz to 3,000 Hz	
Power Source	DC 3V with "AAA" Alkaline battery x 1pcs (not including)	
Battery Life Time	About 6 hours at recording mode (HP Recording)	
	About 5 hours at speaker play at volume 2/3	
Memory	Micro SD card (not including)	
Card Reader	Micro SD card reader (not including)	
Accessories	Earphone	
Size(mm)	100×30×19 mm	

Specifications are subject to change without notice.

14

CARE AND MAINTENANCE

RESETTING THE UNIT

If the unit is exposed to a strong static electrical charge, the unit may lock up,or the display may dim. This is very rare, but if it does happen, remove the battery and then reinstall. All settings will return to their preset values,but the previous messages are saved.

TRAFFIC SAFETY

- .Do not use while operating a motorized vehicle. It may create a traffic hazard and is illegal in many areas.
- .Even if your earphone is an open air type designed to let you hear outside sounds, do not turn the volume up so high that you cannot hear what is around you.
- .Use extreme caution or temporarily discontinue use in potentially hazardous situations.

CARE

- .Keep the unit dry. If it gets wet, wipe it immediately. Liquids may contain minerals that can corrode the circuits.
- .Use and store the unit only in normal temperature environments. Extreme temperatures can shorten the life of electronic devices, damage battery or melt plastic parts.
- . Keep the unit away from dirt and dust.
- .Handle the unit gently and carefully. Dropping it can cause damage and may cause the unit to work improperly.
- .To clean, wipe the unit with a damp cloth occasionally to keep it looking new.
- . Do not use harsh chemicals, cleaning solventsor strong detergents.

13